

Varenummer: 0102180
 Beskrivelse: Seeger låsering J 265 DIN 472
 Fjederstål

Mål

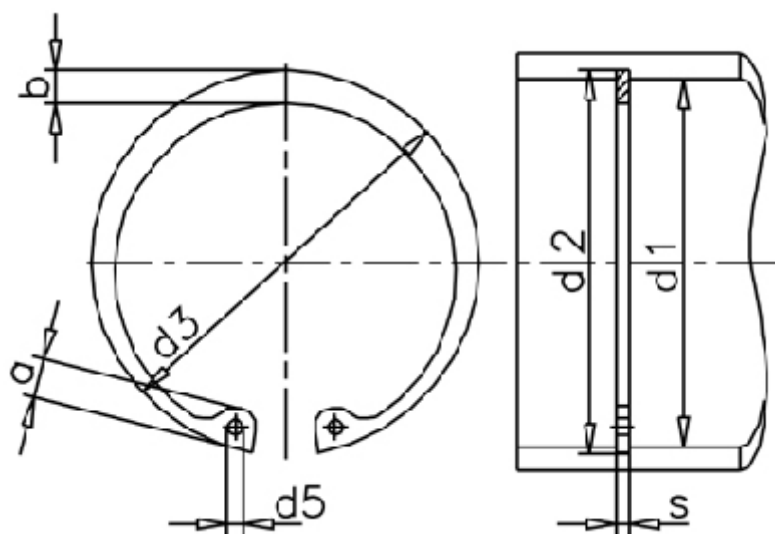

a max	= 16,2	FN kN	= 563.00	t	= 4.00
AN mm ²	= 3380.0	FRg kN	= 78.5	Tang	= ZGJ-5
b	= 16.0	FR kN	= 528.0	tol	= -0.12
Betegnelse	= J 265	g	= 4.0	tol	= +2,00-0,81
d1	= 265	K kN-mm	= 1210.0	tol	= +0,81
d2	= 273.0	m min	= 5.15	vægt kg/1000	= 383.00
d3	= 280.00	Nominel træk	= 12.0		
d5 min	= 5.0	s	= 5.00		